

# Soccer

ALGE-TIMING



# Manual

## Important Information

### General

Before using your **ALGE-TIMING** device read the complete manual carefully. It is part of the device and contains important information about installation, safety and its intended use. This manual cannot cover all conceivable applications. For further information or in case of problems that are mentioned not at all or not sufficiently detailed, please contact your **ALGE-TIMING** representative. You can find contact details on our homepage [www.alge-timing.com](http://www.alge-timing.com)

### Safety

Apart from the information of this manual all general safety and accident prevention regulations of the legislator must be taken into account.

The device must only be used by trained persons. The setting-up and installation must only be executed according to the manufacturer's data.

### Intended Use

The device must only be used for its intended applications. Technical modifications and any misuse are prohibited because of the risks involved! **ALGE-TIMING** is not liable for damages that are caused by improper use or incorrect operation.

### Power supply

The stated voltage on the type plate must correspond to voltage of the power source. Check all connections and plugs before usage. Damaged connection wires must be replaced immediately by an authorized electrician. The device must only be connected to an electric supply that has been installed by an electrician according to IEC 60364-1. Never touch the mains plug with wet hands! Never touch live parts!

### Cleaning

Please clean the outside of the device only with a smooth cloth. Detergents can cause damage. Never submerge in water, never open or clean with wet cloth. The cleaning must not be carried out by hose or high-pressure (risk of short circuits or other damage).

### Liability Limitations

All technical information, data and information for installation and operation correspond to the latest status at time of printing and are made in all conscience considering our past experience and knowledge. Information, pictures and description do not entitle to base any claims. The manufacturer is not liable for damage due to failure to observe the manual, improper use, incorrect repairs, technical modifications, use of unauthorized spare parts. Translations are made in all conscience. We assume no liability for translation mistakes, even if the translation is carried out by us or on our behalf.

### Disposal

If a label is placed on the device showing a crossed out dustbin on wheels (see drawing), the European directive 2002/96/EG applies for this device.

Please get informed about the applicable regulations for separate collection of electrical and electronical waste in your country and do not dispose of the old devices as household waste. Correct disposal of old equipment protects the environment and humans against negative consequences!



### Copyright by **ALGE-TIMING GmbH**

All rights reserved. Any duplication, either in full or in part, requires the prior written consent of the copyright holder.

## Table of contents

<b>1</b>	<b>Introduction</b> .....	<b>4</b>
<b>2</b>	<b>Football scoreboard type FB</b> .....	<b>4</b>
<b>3</b>	<b>Installation type FB</b> .....	<b>5</b>
3.1	How to mount the score board type FB.....	6
3.2	Cable Installation .....	6
3.2.1	Net cable.....	8
3.2.2	Data cable.....	8
3.2.3	Terminal circuit board (Score Board) .....	9
<b>4</b>	<b>FB score board types</b> .....	<b>10</b>
<b>5</b>	<b>FA score board types</b> .....	<b>11</b>
<b>6</b>	<b>Start-up the Timy</b> .....	<b>12</b>
<b>7</b>	<b>Operation of the program</b> .....	<b>13</b>
7.1	"F0" Game or day time .....	13
7.2	"F1" Test .....	13
7.3	"F2" New.....	13
7.4	"F3" 2HA .....	13
7.5	Input goals .....	13
7.6	CLR button.....	14
7.7	More adjustments .....	14
7.7.1	TIME .....	14
7.7.2	ONLY MINUTES.....	14
7.7.3	TIME OUT.....	14
7.7.4	TEST.....	14
7.7.5	MASK.....	15
7.7.6	BOARD .....	15
7.7.7	SCORE .....	15
7.7.8	AUTO-STOP.....	15
<b>8</b>	<b>Trouble shooting</b> .....	<b>15</b>
8.1	Self test of the score board.....	15
8.2	No function of the score board .....	16

The contents of this manual are subject to change without notice!

manual copyright by:

ALGE-TIMING  
AUSTRIA

## 1 Introduction

There are different types to indicate the results for football

FB	particularly produced for football
FA	based on a standard scoreboard
GAZ	standard scoreboard
D-LINE	scoreboard with LED technology

## 2 Football scoreboard type FB

The Alge Football Score Board consists of the following parts:

Score Board:	Public information board for football (and athletics)
Timy XE:	Terminal to control the score board
Cable 206-10:	Cable between Timy and connection box in the speaker shack
Connection box 095 or 096:	Connection between the permanent cable from the score board to the speaker shack and cable 206-10 to the Timy
Fastening block:	To fasten the score board on the supporting beams
OPTION: Supporting Beam:	For score board installation



### 3 Installation type FB

The supporting beams must be anchored in the ground . We recommend to ask a local static calculation engineer for help. The supporting beams must be 100% stabilized when you mount the score board.

Behind the score board you need 1 meter space, because in case of defects, repairs have to be done from the backside.

The supporting beams must be set up in a distance of 2.9 meter. All measurements in the drawing are given in millimetres.

We recommend for the supporting beams concrete pipe that is concreted in the natural earth. In this pipe you can put the beams, align them, and fill it with gravel.

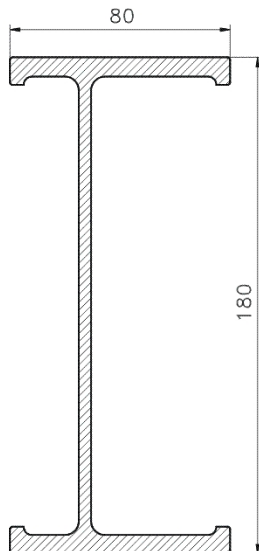
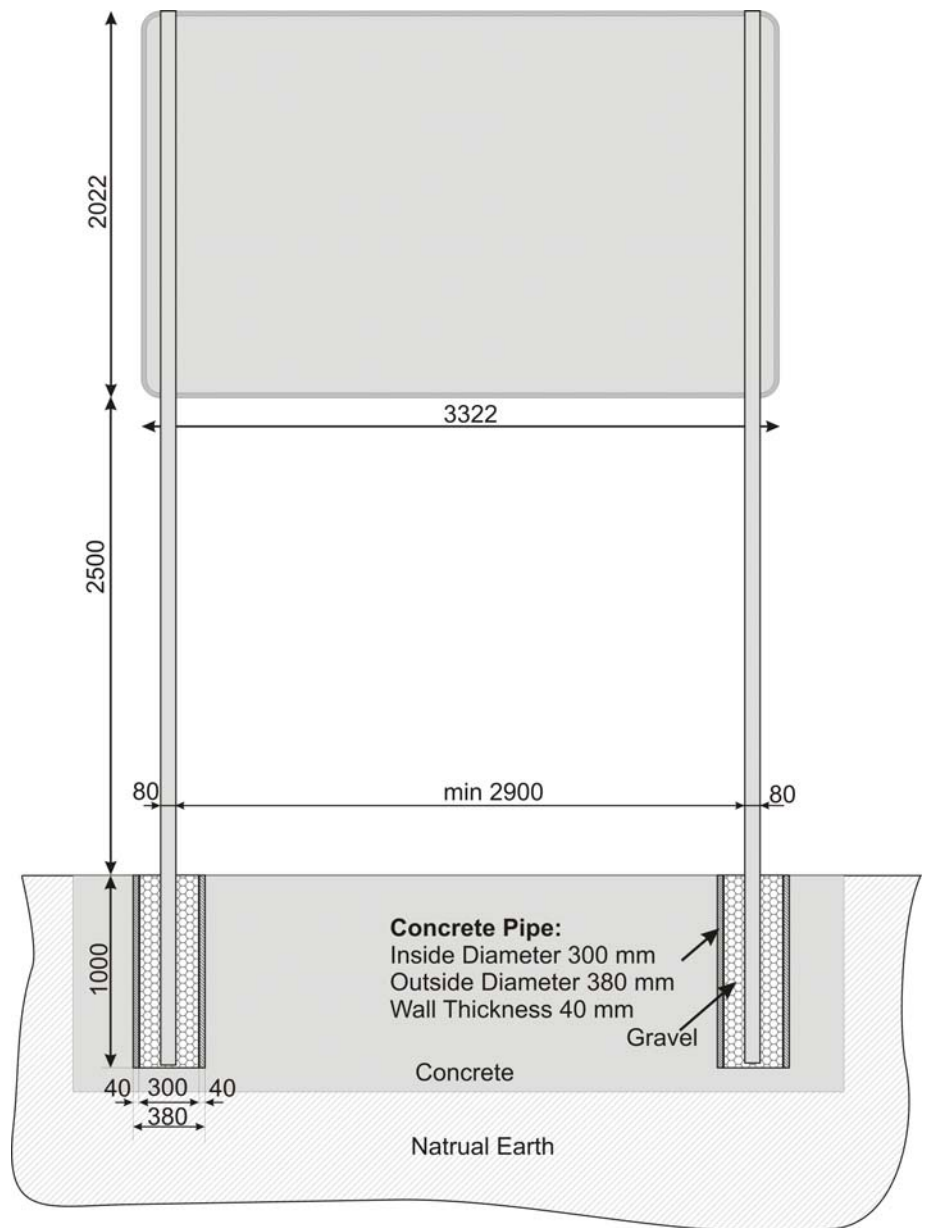

Both supporting beams have a length of 5.5 m ( 1 m inside the ground ). In the picture to the left you can see a cross-section of a supporting beam. The measurements are given in millimetres.

### 3.1 How to mount the score board type FB

Mount the score board with the fastening blocks at the support beams.

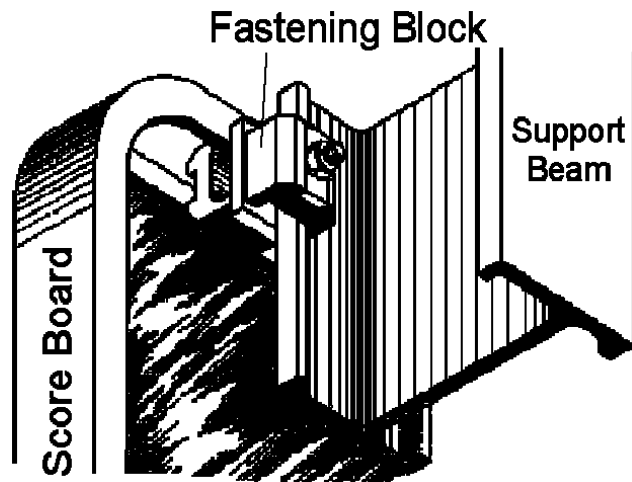

### 3.2 Cable Installation

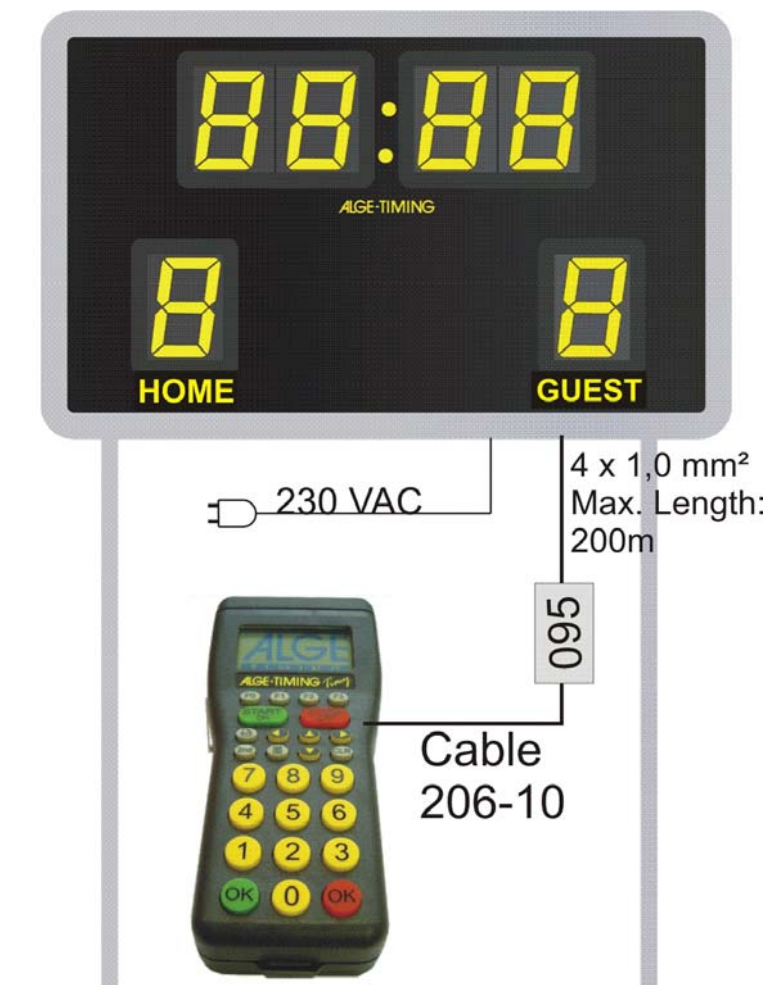

## Installation in a Stadium in connection with a Athletic Score Board:

- ☞ Football Score Board FL845
- ☞ Football Score Board FL045

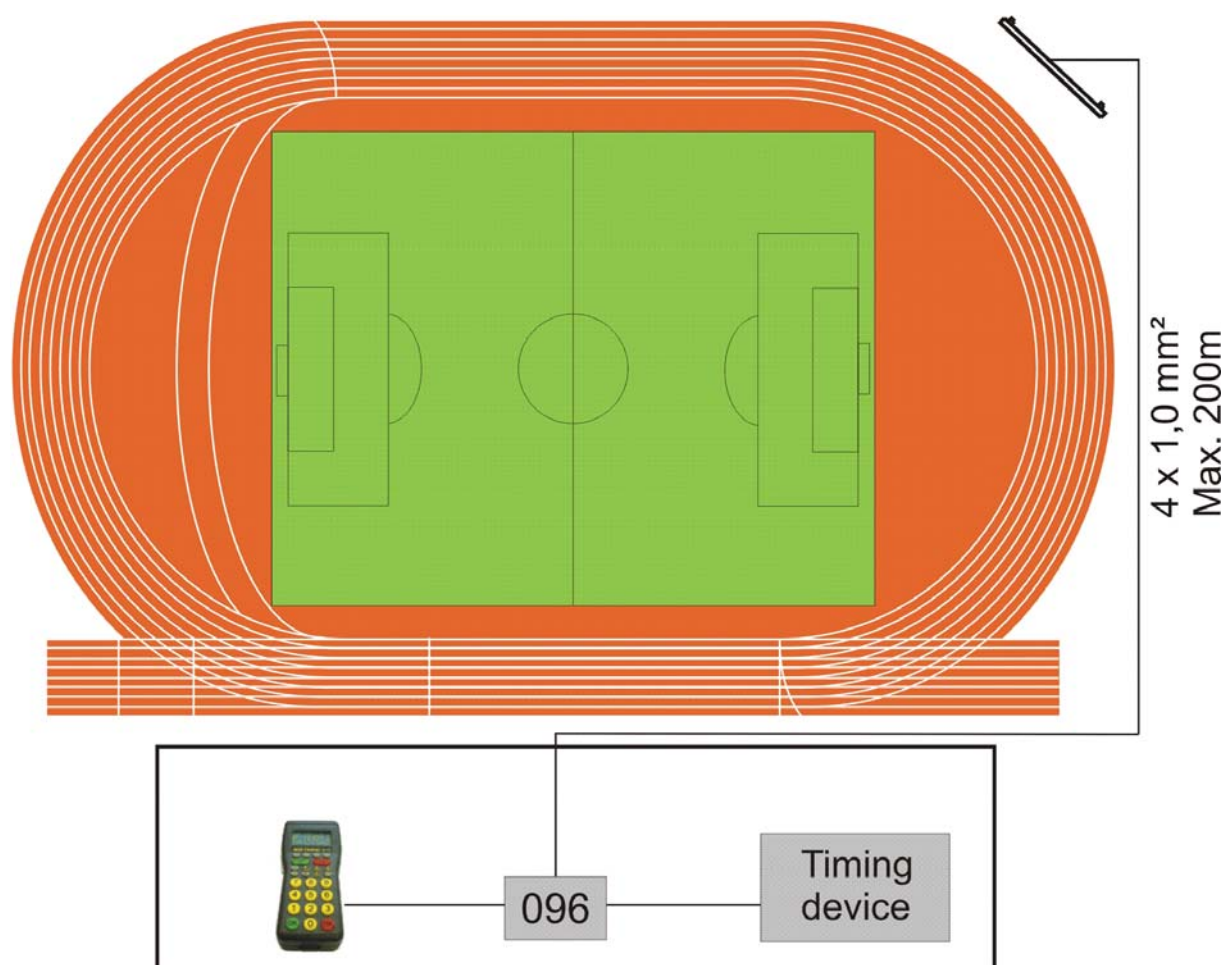

The score board FL845 and FL045 have the possibility to show the running time during an athletic event. The time is shown on six digits in minutes, seconds and 1/100 seconds.

You can choose between football and athletic mode with the connection box 096.  
You can also take the Timy for the athletics.

### 3.2.1 Net cable

For the score board you need 230 VAC power supply (cable with minimum 3 x 1,5 mm<sup>2</sup>). The rules for electric installations must be considered. Never install the data cable and net cable in the same installation pipe.

We recommend to call an electrician for this.

### 3.2.2 Data cable

For the score board you need to install a data cable 4 x 1,0 mm<sup>2</sup> with maximum length of 200 meters to the speaker shack.

An Amphenol-device-plug is mounted at the score board.

At the data cable on the score board side you have to munt an Amphenol-cable-socket, on the speech shack side an Amphenol-cable-plug. They are through-wired straight.

**Cable from the score board to the connection box:**

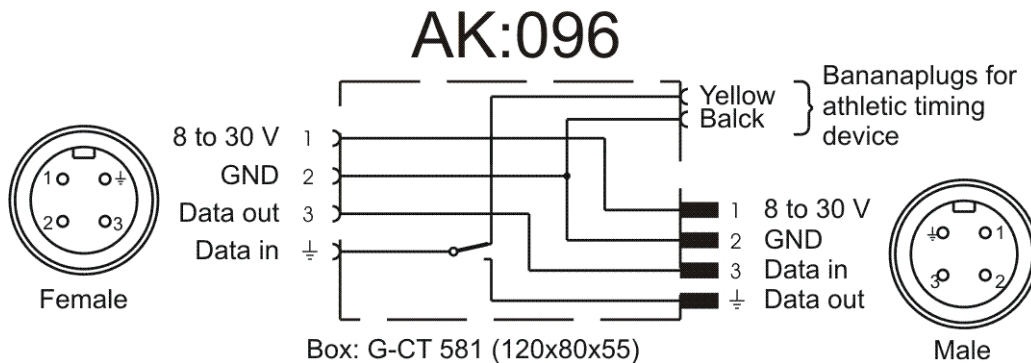
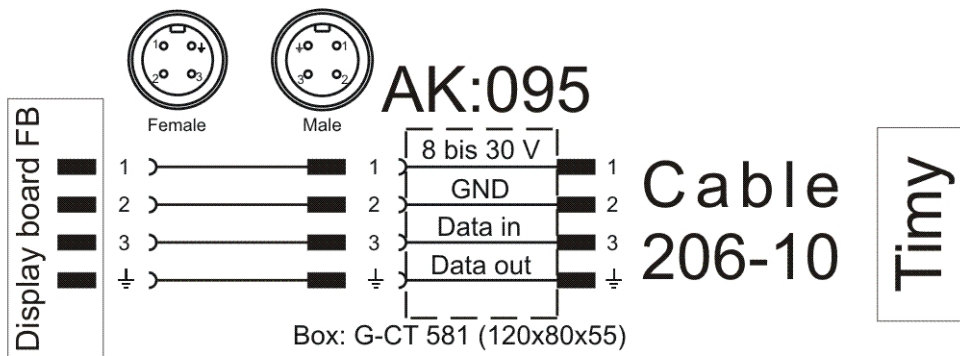

### 3.2.3 Terminal circuit board (Score Board)

The electronic is in the white box on the backside of the score board. To install the score board, it's not necessary to open the box. The net cable for the power supply and an Apmhenol-device-plug for the data connection is available from the outside.

If you have difficulties with the score board during the installation or operation, control first the fuses and LED. In order to reach the Terminal circuit Board, remove the four screws of the plastic case and lift the cover.

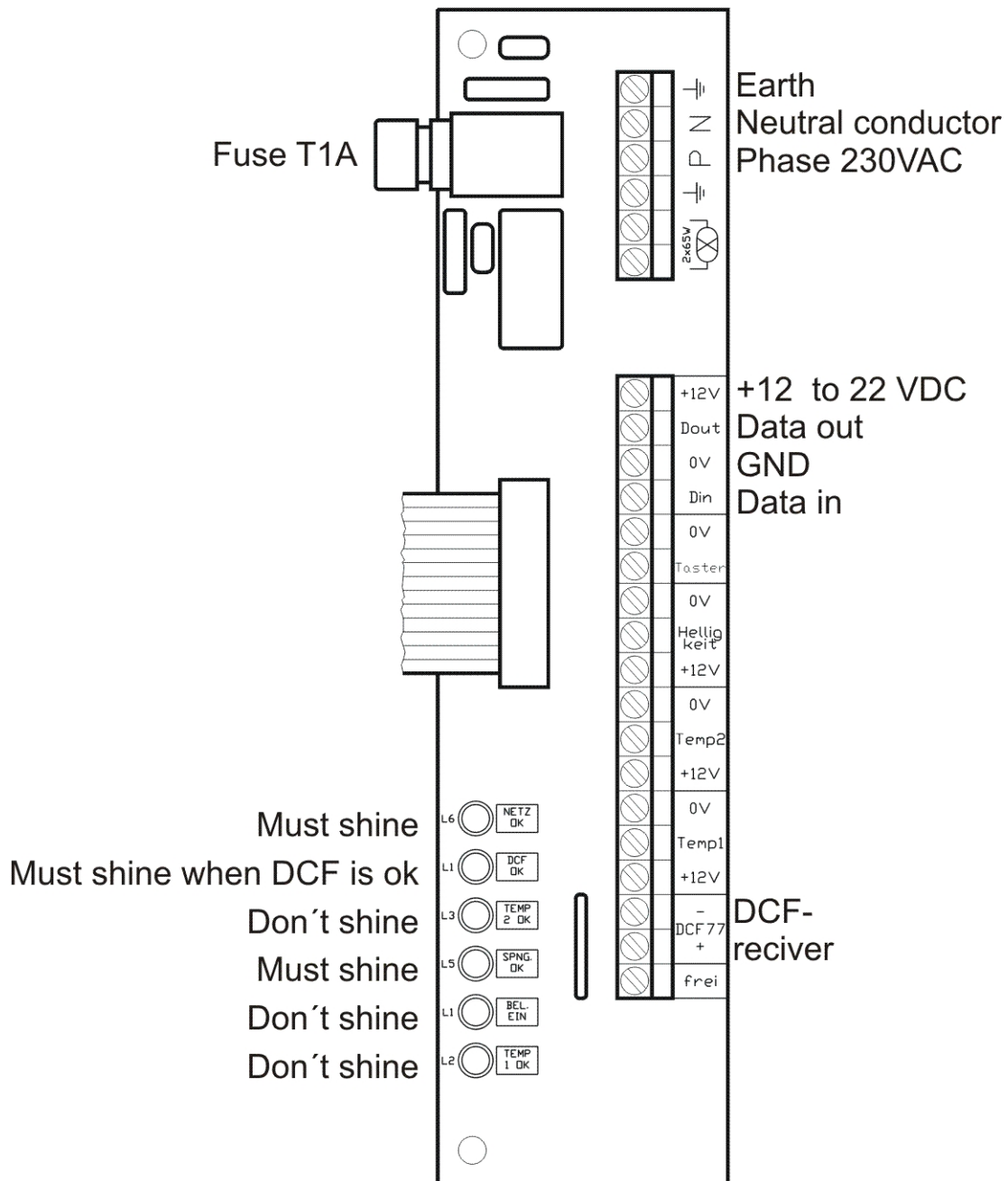

## 4 FB score board types

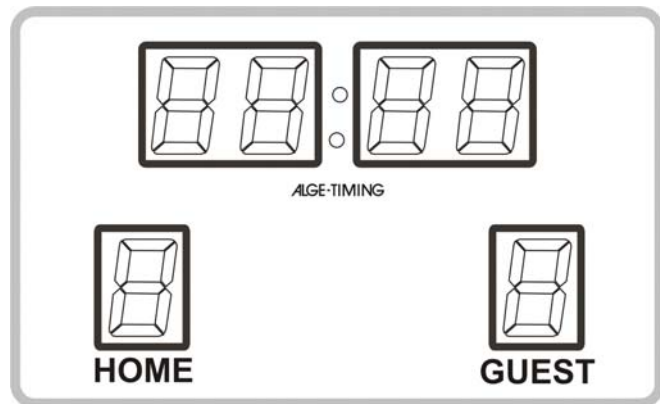
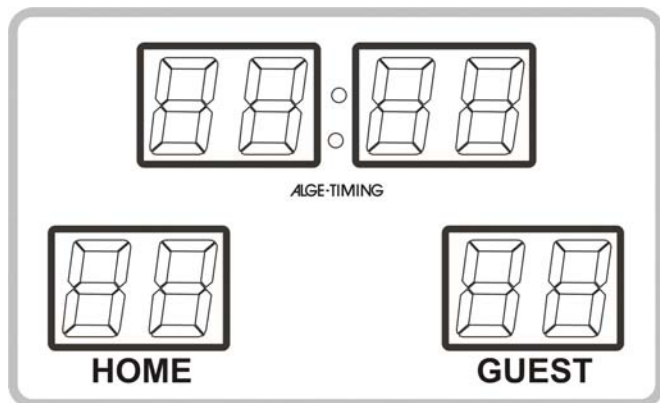
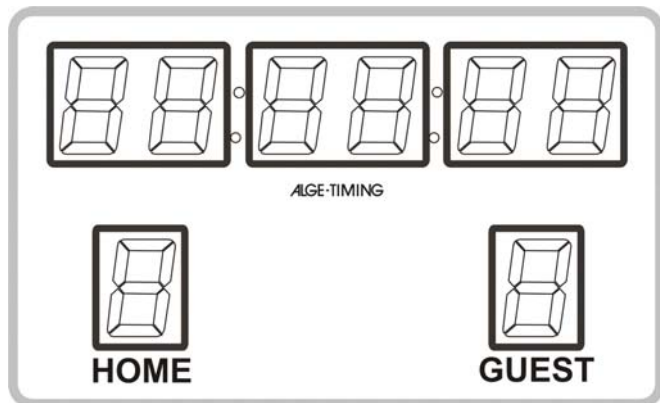
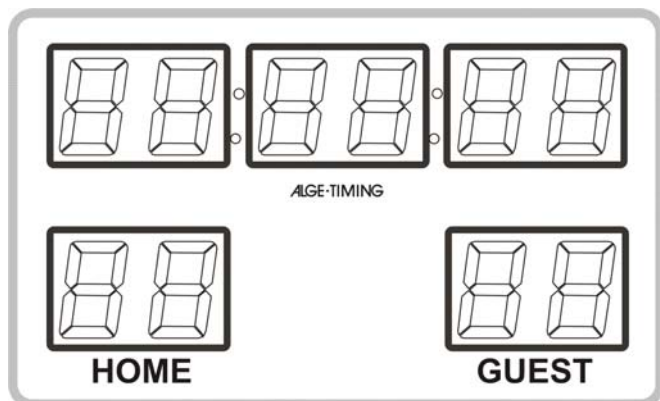
**FB645****FB845****FL845****FL045**

## 5 FA score board types

FA 445:

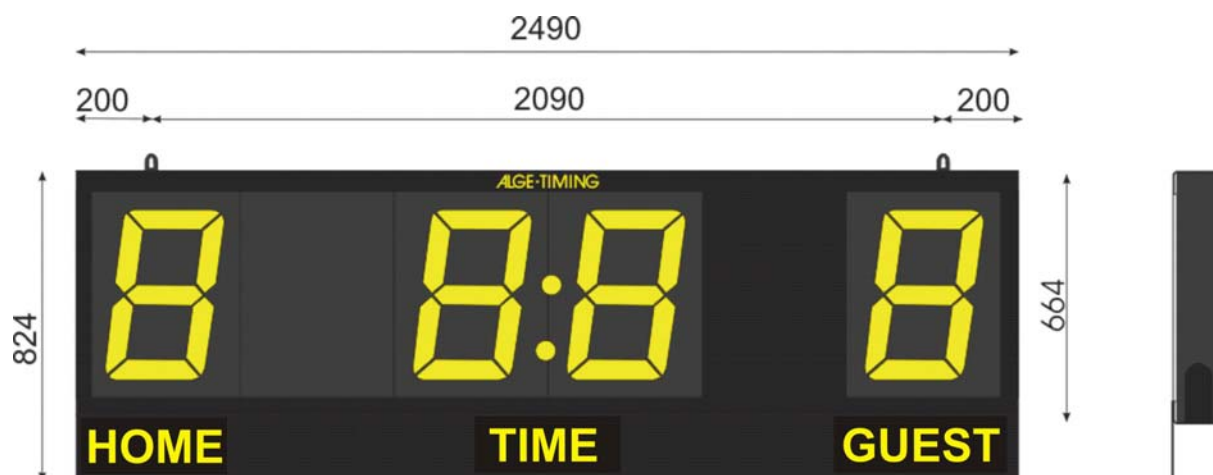

FA 645-T:



FA 645-G:



The electronic is on the right side of the score board like a normal GAZ display board.

## 6 Start-up the Timy

The TIMY has got a weather-proof (and water-proof) silicone keypad. The keypad is ideal for outdoor-usage. The keys are raised and have ideal pressure points and although the TIMY has got small dimensions, they are easy to operate.



**Control keys:** These keys are used all-purpose. You can always see the function in the display.



**START/ON:** Key for manual start impulse and to switch-on the Timy.



**STOP/OFF:** Key for manual stop impulse and to switch-off the Timy.



**Printer:** Key for paper output. If you press the combination **2nd** and , you will get into the printer menu.



**2nd:** This key is always used in combination with a second key (additional function).



**Menu:** Key to enter the device menu



**CLR:** Key to clear the marked times or to clear the memory.



**Cursor:** Keys to move the cursor in the display.

 +  Beginning of a list

 +  End of a list



**OK green:** To confirm the commands, to confirm start inputs or to switch it on.



**OK red:** To confirm the commands, to confirm finish inputs or to switch it off.

## 7 Operation of the program

Please read the Timy manual GENERAL how to start the Timy.

The Timy and the scoreboard were configured correctly and should function after correct installation of the scoreboard immediately.

You can operate a standard score board, D-LINE and the football score board with this program.

### 7.1 “F0” Game or day time

With the “F0” key you can switch between the game or day time.

Always the bigger writing is active.



### 7.2 “F1” Test

When you push this button, a automatic display board test will be started. The display board switches between eight and blank.

To stop the test, press the “F0” button.



### 7.3 “F2” New

Here you can input a new game time or a new daytime.

### 7.4 “F3” 2HA

2HA = second half time. When you press the “F3” button the Timy will ask you: “Confirmation second half”. Confirm this with Yes (F0 or F1) or with no (F2 or F3). When Yes the Timy switch in the game time mode with a default time of 45 min.

### 7.5 Input goals

You can input the goals in the game or day time mode. The green “OK” button is for the “home” goals, the red for the “guest” goals. You can also input the goals directly. Give in the right goal and confirm it with the right “OK” button. To count down the goals, press the “2<sup>nd</sup>” and the red or green “OK” button.

## **7.6 CLR button**

When you want to have a blank display board, press the “CLR” button.

In this program you can make further adjustments which you can find like described in point 2.1.

## **7.7 More adjustments**

### **7.7.1 TIME**

Here you can adjust if the time count up or down. Also you can enter a new day time. When count down, the next point can adjusted.

### **7.7.2 ONLY MINUTES**

Adjustment possibilities are YES or NO. Yes means, when the time starts to count down (e.g. 5 min.) the change of the minute occurred when the Timy display shows 3min 59sec. The Timy will give a beep when the count down is finished.

### **7.7.3 TIME OUT**

Adjustment possibility to make a time out or not

### **7.7.4 TEST**

Possibility to make a second automatic display board test.

- ☞ Power on test
- ☞ Day time test
- ☞ Day time off

Power on test means, each time when you switch on the Timy and you go into the Football program, the Timy will start the display board test which is explained in point 2.7.2.

Day time test means, the test starts on a specific day time. To deactivate the tests, go to “Day time off” and confirm with a “ok” button.

## 7.7.5 MASK

Here you can program the football scoreboards.

- ☞ FB 645
- ☞ FB 845
- ☞ FL 845
- ☞ FL 1045

We recommend to make this not on your one, only by an ALGE representatives.

## 7.7.6 BOARD

Here you can adjust the type and the display mode.

- ☞ GAZ                    standard display board
- ☞ TIMETEMP          Football scoreboard
- ☞ D-LINE              LED-scoreboard

	GAZ4 6xx	D-LINE 6xx	Production
Adjustment			
6 DIG H- MM –G	YES	YES	
8 DIG			

## 7.7.7 SCORE

The adjustments are, “at game only” or “always”.

AT GAME ONLY means, the score is only in the game time mode visible.

ALWAYS means, the score is also in the daytime mode visible.

## 7.7.8 AUTO-STOP

Automatic game time stop after 45 and 90 min.

# 8 Trouble shooting

## 8.1 Self test of the score board

- ☞ Switch off the score board
- ☞ Make a short cut on the circuit board between „0V“ and „Taster“
- ☞ Switch on the score board
- ☞ Each didgit gets a number
- ☞ Release the short cut
- ☞ Make again the short cut
- ☞ It moves each segment of each digit

In order to Stopp the self test switch off the score board and release the short cut.

## **8.2 No function of the score board**

### **Check the power supply:**

- ☞ Top LED and fourth LED from the top must shine

### **LED does not shine:**

- ☞ Did you plug 230 Volt plug
- ☞ Is the net cable to the score board OK
- ☞ Control the fuse of the 230 Volt net
- ☞ Check the fuses of the score board

### **All LED's are shining:**

- ☞ Selftest is running.

### **Selftest is not working:**

- ☞ Change the main circuit board (CPU)

### **No connection to the score board:**

- ☞ Plug the Timy with cable 206-10 directly to the score board
- ☞ Check fuses
- ☞ Make the Selftest